

Agilent 87222C/D/E Coaxial Transfer Switches dc to 26.5, 40, 50 GHz

Product Overview

High performance transfer switches for microwave and RF instrumentation and systems

- Exceptional repeatability for more than 5 million cycles
- Excellent isolation, typically >90 dB at 26.5 GHz; >60 dB at 40, 50 GHz
- Opto-electronic indicators and interrupts
- Magnetic latching
- TTL/5V CMOS compatible

Flexibility is essential in signal routing applications, and the Agilent Technologies 87222C/D/E 4-port coaxial transfer switches offer just that. They provide exceptional repeatability, low insertion loss, and high isolation. These switches provide simplification of design in signal routing and conditioning applications.

The 87222C/D/E can be used in a variety of applications, such as a drop-out switch, switching two inputs and two outputs, or signal reversal switching.

Description

Innovative design and careful process control mean the 87222C/D/E meet the requirements for highly repeatable switching elements in test instruments and switching interfaces. These switches are designed to operate for more than 10,000,000 cycles. They offer exceptional insertion loss repeatability, reducing sources of random errors in the measurement path and improving measurement uncertainty.

Switch life is a critical consideration in production test systems, satellite and antenna monitoring systems, and test instrumentation. The longevity of these switches increases system uptime and lowers the cost of ownership by reducing calibration cycles and switch maintenance.

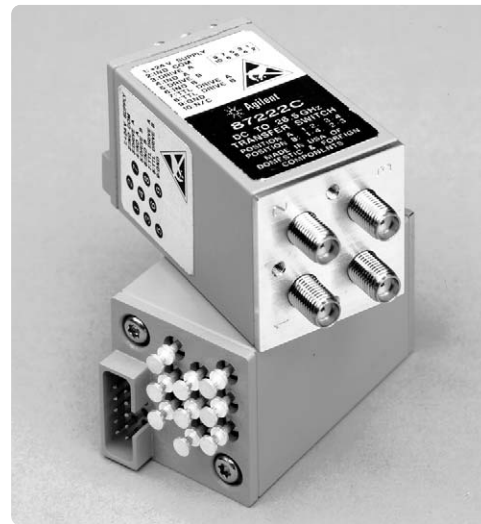

Microwave Test Accessories



Agilent Technologies

Operating from dc to 50 GHz, these switches exhibit exceptional isolation performance required to maintain measurement integrity. Isolation between ports is typically >100 dB to 12 GHz, >90 dB to 26.5 GHz, and >60 dB to 50 GHz, reducing the influence of signals from other channels and system measurement uncertainties. Hence, the 87222C/D/E are ideal elements in large, multi-tiered switching systems.

The Agilent 87222C/D/E are designed to fall within most popular industry footprints. The 1¼ inch square flange provides tapped mounting holes, while the rest of the 2¾ inch long by 1¼ inch square body will easily fit into most systems. The

standard 10-pin ribbon drive cable or optional solder terminal connections accommodate the need for secure and efficient control cable attachment.

Opto-electronic interrupts and indicators improve reliability and extend the life of the switch by eliminating DC circuit contact failures characteristic of conventional electromechanical switches. The 87222C/D/E have circuits that interrupt the current to all the solenoids once switching is complete and offer independent indicators that are controlled by optical interrupts. These indicators provide a closed path between the indicator common pin and the corresponding sense pin of the selected path.

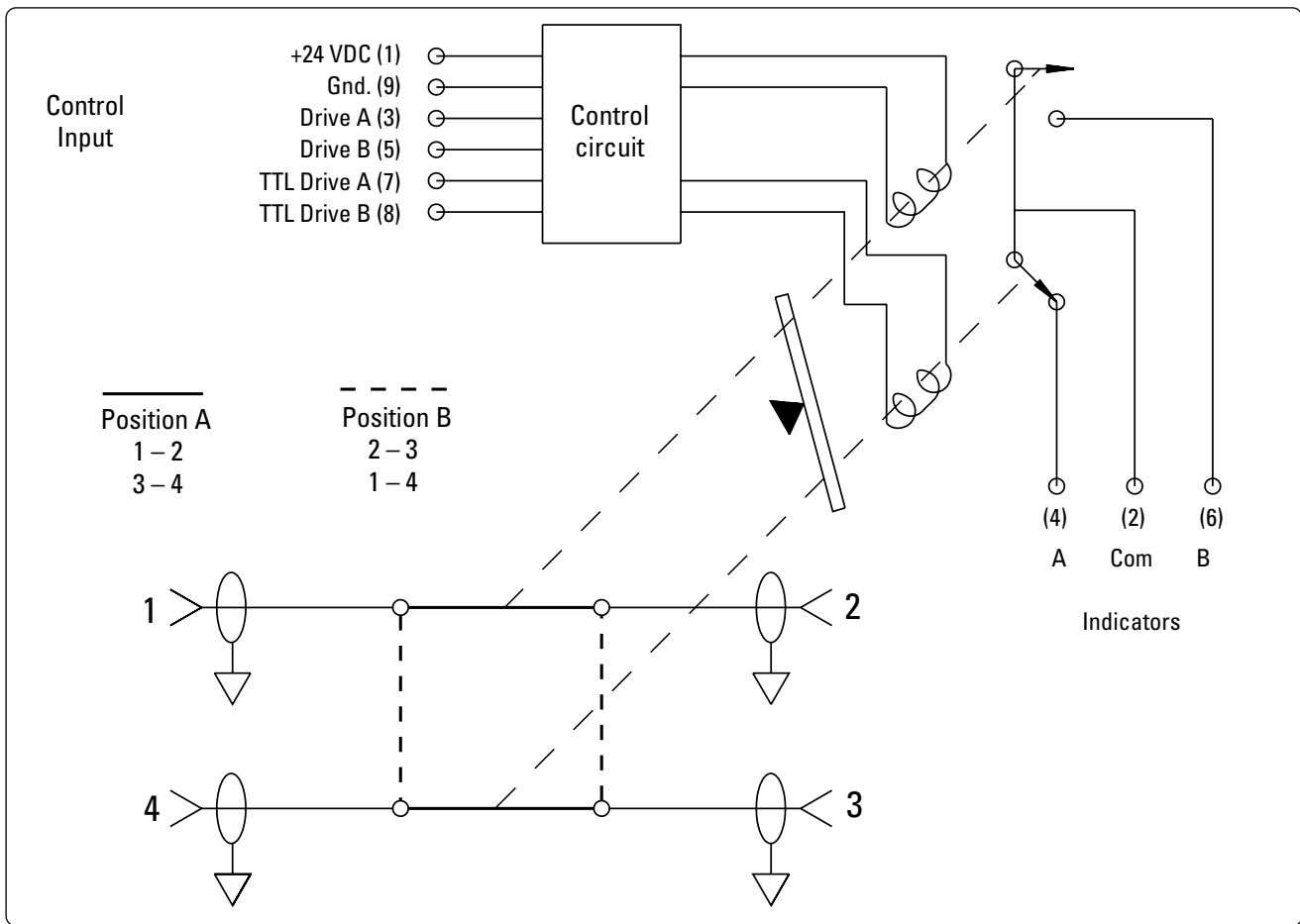

Figure 1. Agilent 87222C/D/E schematic

Applications

The Agilent 87222C/D/E transfer switches can be used in many different applications to increase system flexibility and simplify system design. The following are five examples: switch between two inputs and two outputs, use as a drop-out switch, use for signal reversal, configure as a SPDT switch, and bypass an active device.

The 87222C/D/E transfer switches have the ability to exchange two signals between two inputs and two outputs. Either transfer switch can connect two different instruments with two devices under test (DUT). Once switched, the signals are exchanged between the two instruments and the two DUTs. The exchanged signals allow complete network and spectrum analysis on two devices with a single switch and one test setup. See Figure 2 for an example of this application.

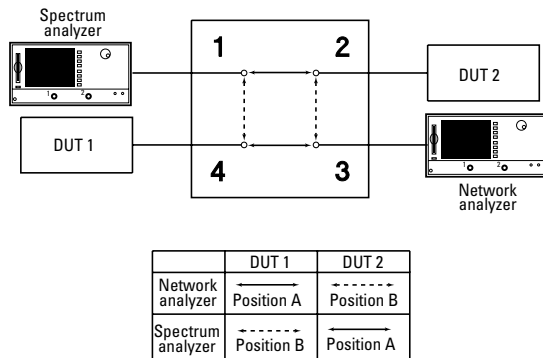
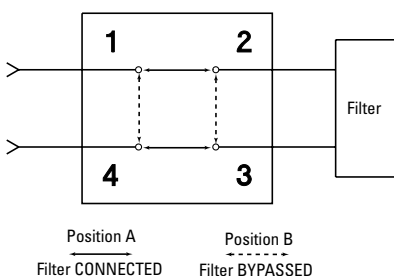

Figure 2. Switching two instruments and two DUTs

The 87222C/D/E can be used as a simple drop-out switch where a signal is either run through the device under test or straight through the switch, bypassing the device. See Figure 3.

Figure 3. Drop-out switch



In the signal reverse configuration, a device can be connected across two diagonal ports of the 87222C/D/E transfer switch. This will allow the signal direction through the device to be reversed. See Figure 4.

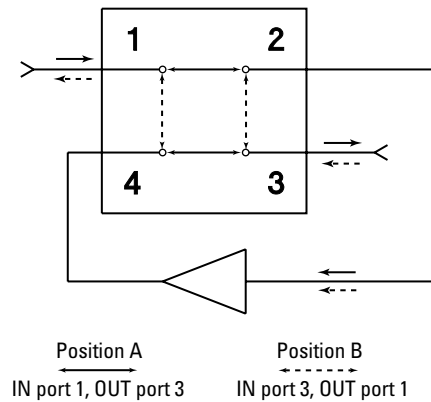

Figure 4. Signal reversal

By attaching an external termination, the designer can use the 87222C/D/E in a SPDT terminated switch configuration. See Figure 5.

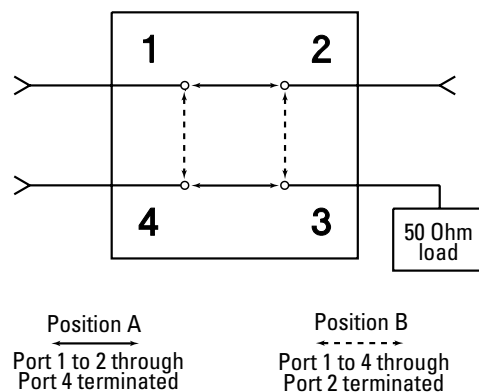

Figure 5. SPDT terminated

In Figure 6, an active device, such as an amplifier, is inserted into a signal path presenting a unique problem. A single transfer switch has the undesirable characteristic of shunting the output of the amplifier to its input when the signal is bypassing the amplifier. The advantage of using two transfer switches is that an additional signal path is available, however two SPDT switches can also be used. This additional path can utilize the same amplifier when the original path is bypassed.

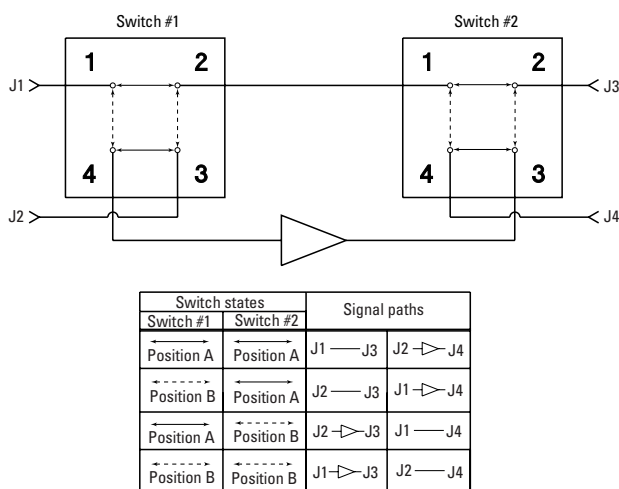

Figure 6. Bypassing an active device

Driving the switch

There are two positions for the 87222C/D/E transfer switches. See Table A. Position A has RF Port 1 connected to RF Port 2 and RF Port 3 connected to RF Port 4. Position B has RF Port 2 connected to RF Port 3 and RF Port 1 connected to RF Port 4. Either switch can be driven with a standard grounding drive control with or without a separate ground. Single line or Dual line TTL control are also available. The switch operates in a break-before-make mode. See Figure 7.

“CAUTION FOR USERS OF THE AGILENT 11713A SWITCH DRIVER: Do not drive the 87222C/D/E using the S9 or SO outputs from either the banana plugs or from pins 3 or 4 within the Atten X and Atten Y Viking sockets located on the rear panel of the 11713A.”

(I) Standard drive:

See Figure 8 for drive connection diagrams.

- Connect pin 1 to supply (+20 VDC to +32 VDC).
- Connect pin 9 to ground (see Note 1).
- Select position A by applying ground to pin 3 (see Note 3).
- Select position B by applying ground to pin 5 (see Note 3).

(II) Single line TTL drive:

See Figure 8 for drive connection diagrams.

See Figure 9 for TTL voltage states.

- Connect pin 1 to supply (+20 VDC to +32 VDC).
- Connect pin 9 to ground (see Notes 2, 4).
- Connect pin 8 to TTL “High.”
- Select position A by applying TTL “High” to pin 7 (see Note 3).
- Select position B by applying TTL “Low” to pin 7 (see Note 3).

(III) Dual line TTL drive:

See Figure 8 for drive connection diagrams.

See Figure 9 for TTL voltage states.

- Connect pin 1 to supply (+20 VDC to +32 VDC).
- Connect pin 9 to ground (see Notes 2, 4).
- Select position A by applying TTL “High” to pin 7 and TTL “Low” to pin 8 (see Note 3).
- Select position B by applying TTL “Low” to pin 7 and TTL “High” to pin 8 (see Note 3).

Notes:

1. Pin 9 does not need to be grounded for the switch to operate in standard drive mode. If pin 9 is not grounded, the position indicators will only function while the appropriate drive has ground applied. Therefore, if a pulse drive is used and continuous indicator operation is required, pin 9 must be grounded.
2. For TTL drive, pin 9 must be grounded.
3. After the RF path is switched and latched, the drive current is interrupted by the electronic position-sensing circuitry. Pulsed control is not necessary, but if implemented, the pulse width must be 15 ms minimum to ensure that the switch is fully latched.
4. In addition to the quiescent current supplying the electronic position-sensing circuitry, the drive current flows out of pin 9 (during switching) when using TTL drive.

Table A. Drive control alternatives

RF path	(I) Standard drive voltage		(II) Single line TTL/5V CMOS drive voltage		(III) Dual line TTL/5V CMOS drive voltage	
	Drive A Pin 3	Drive B Pin 5	TTL Drive A Pin 7	TTL Drive B Pin 8	TTL Drive A Pin 7	TTL Drive B Pin 8
Position A 1 to 2, 3 to 4	Ground	Open	High	High	High	Low
Position B 2 to 3, 1 to 4	Open	Ground	Low	High	Low	High

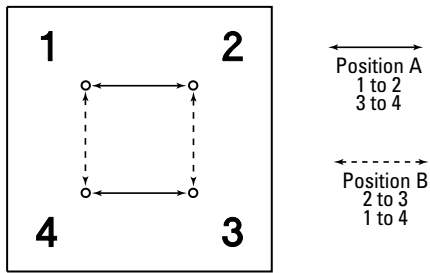

Figure 7. RF port connections

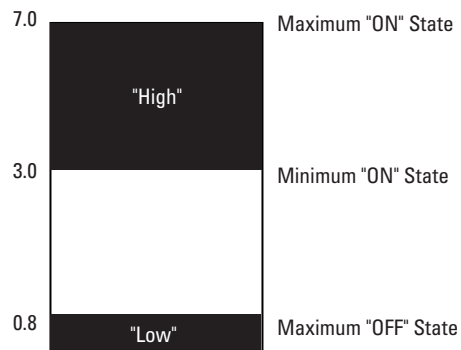

Figure 9. TTL control voltage states

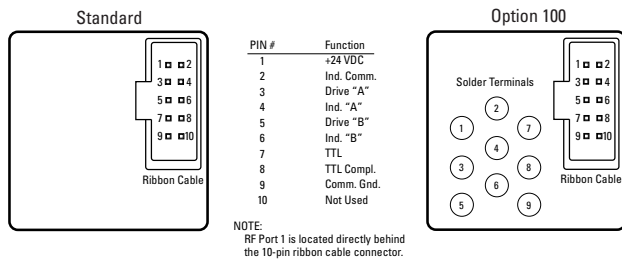

Figure 8. Drive connections

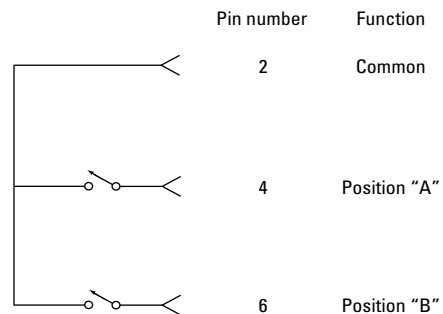

Figure 10. Indicator function diagram

Electronic position indicators

The independent electronic position indicators consist of optically isolated, solid-state relays, which are driven by photo-electric sensors coupled to the mechanical position of the RF path's moving elements. See Figure 10. The circuitry consists of a common which can be connected to an output corresponding to either position A or position B. The solid state relays are configured for AC and/or DC operation. (See indicator specifications.) The electronic position indicators require that the supply (+20 VDC to +32 VDC) be connected to pin 1 but requires that pin 9 be grounded if pulse drive is used and continuous indicators operation is desired. If pin 9 is not grounded, the position indicators will function while the appropriate drive has ground applied.

Specifications

Specifications describe the instrument's warranted performance. Supplemental and typical characteristics are intended to provide information useful in applying the instrument by giving typical, but not warranted performance parameters.

Table B. Standard switch drive specifications

Parameter	Conditions	Min	Nom	Max	Units
Supply voltage		20	24	32	V
Supply current, I _{cc}	Switching: Pulse width >15 ms: V _{cc} = 24 VDC		200		mA
Supply current (Quiescent)		25		50	mA

Table C. TTL Specific drive specifications

Parameter	Conditions	Min	Nom	Max	Units
High level input		3		7	V
Low level input				0.8	V
Max high input current	V _{cc} = Max V input = 3.85 VDC		1	1.4	mA

General operating data

Nominal/Impedance	50 Ω
Maximum power rating	
Switching	1W CW
Non-switching	50W Pk (not to exceed 1 watt average)
Life	5,000,000 cycles minimum
Switching speed	15 ms maximum

Indicator specifications

Maximum withstand voltage	60 V
Maximum current capacity	100 mA
Maximum "ON" resistance	50 Ω
Minimum "OFF" resistance	1 G Ω

Environmental specifications

Operating temperature	-25 to 75°C
Storage temperature	-55 to 85°C
Temperature cycling	55 to 85°C, 10 cycles per MIL-STD-202F, Method 107D, Condition A (modified)

Vibration

Operating Survival	7g, 5 to 2000 Hz at 0.25 inches pk-pk 20g, 20 to 2000 Hz at 0.06 inches pk-pk, 4 min/cycle, 4 cycles/axis
--------------------	---

Random

2.41 g (rms) 10 min/axis

Shock

Half-sine	500 g at 0.5 ms, 3 drops/direction, 18 total
-----------	---

Operating 50 g at 6 ms, 6 directions

Moisture resistance 65° C, 95% RH, 10 days per
MIL-STD-202F, Method 106E

Altitude storage 50,000 feet (15,240 meters per MIL-
STD-202F, Method 105C, Condition B)

RFI Per MIL-STD-461C, RE02, Part 4

Agilent 87222C

Frequency range	dc to 26.5 GHz
Insertion loss	0.2 dB + 0.025 x frequency (GHz)
Isolation	120 dB-2.0 x frequency (GHz)
SWR	1.1 maximum dc to 2 GHz 1.15 maximum 2 to 4 GHz 1.25 maximum 4 to 12.4 GHz 1.4 maximum 12.4 to 20 GHz 1.65 maximum 20 to 26.5 GHz
Insertion loss repeatability	<0.03 dB typical
Connectors	SMA (f)

Agilent 87222D

Frequency range	dc to 40 GHz
Insertion loss	0.2 dB + 0.025 x frequency (GHz)
Isolation	DC-26.5 120 dB-2.0 x frequency (GHz) 26.5-40 60 dB
SWR	1.3 maximum dc to 12.4 GHz 1.4 maximum dc to 12.4 to 25 GHz 1.7 maximum dc to 25 to 40 GHz
Insertion loss repeatability	<0.03 dB typical
Connectors	2.92 mm (f)

Agilent 87222E

Frequency range	dc to 50 GHz
Insertion loss	0.15 dB + 0.020 x frequency (GHz)
Isolation	DC-26.5 120 dB-2.0 x frequency (GHz) 26.5-50 60 dB
SWR	1.3 maximum dc to 12.4 GHz 1.4 maximum 12.4 to 20 GHz 1.5 maximum 20 to 30 GHz 1.6 maximum 30 to 40 GHz 1.7 maximum 40 to 50 GHz
Insertion loss repeatability	DC-40 GHz < 0.03 dB typical 40-50 GHz < 0.05 dB typical
Connectors	2.4 mm (f)

Agilent 87222C/D/E physical specifications

Dimensions	Per Figure 13
Weight	100 gm (0.23 lb)

Supplemental characteristic

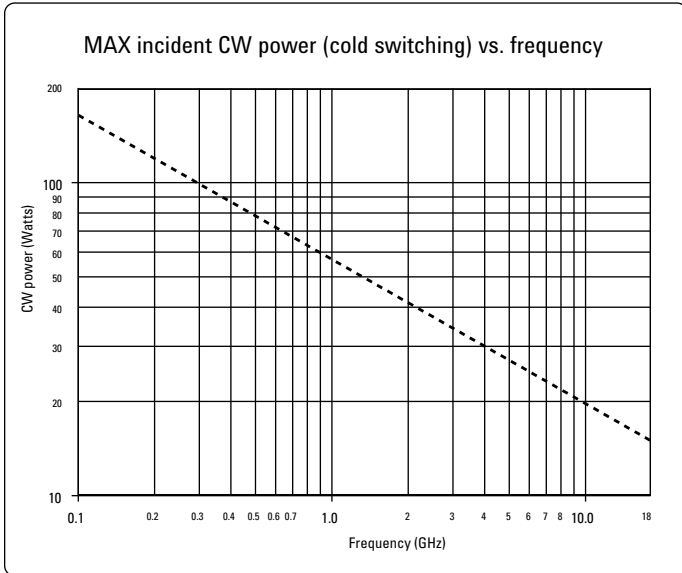

Reference conditions:

- Cold switching only (NO Hot switching)
- Ambient temperature of 75°C or less
- Sea level (0.88 derating @ 15,000ft.)
- Load VSWR < 1.2 (see graph for derating above 1.2 VSWR)

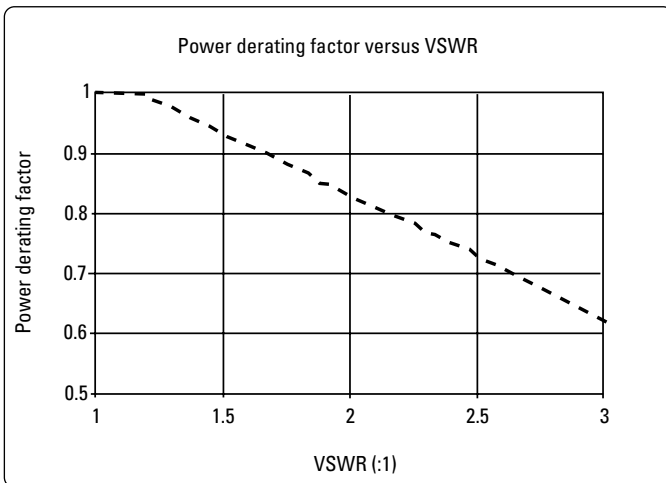

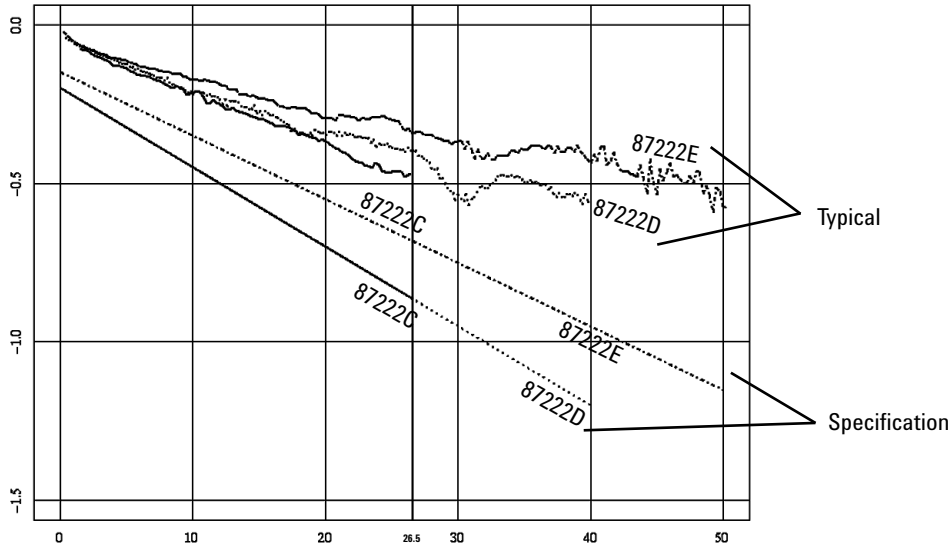

Figure 11. Agilent 87222C/D/E insertion loss versus frequency

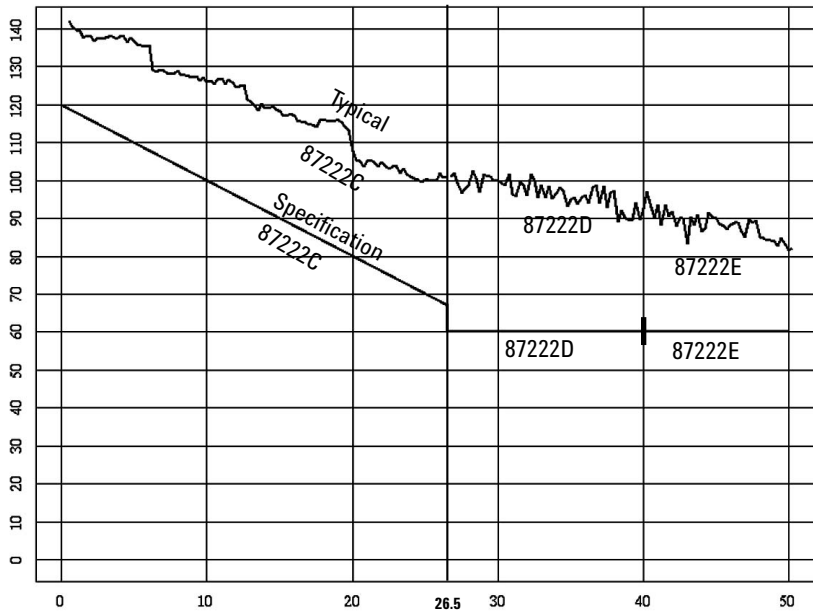

Figure 12. Agilent 87222C/D/E isolation versus frequency

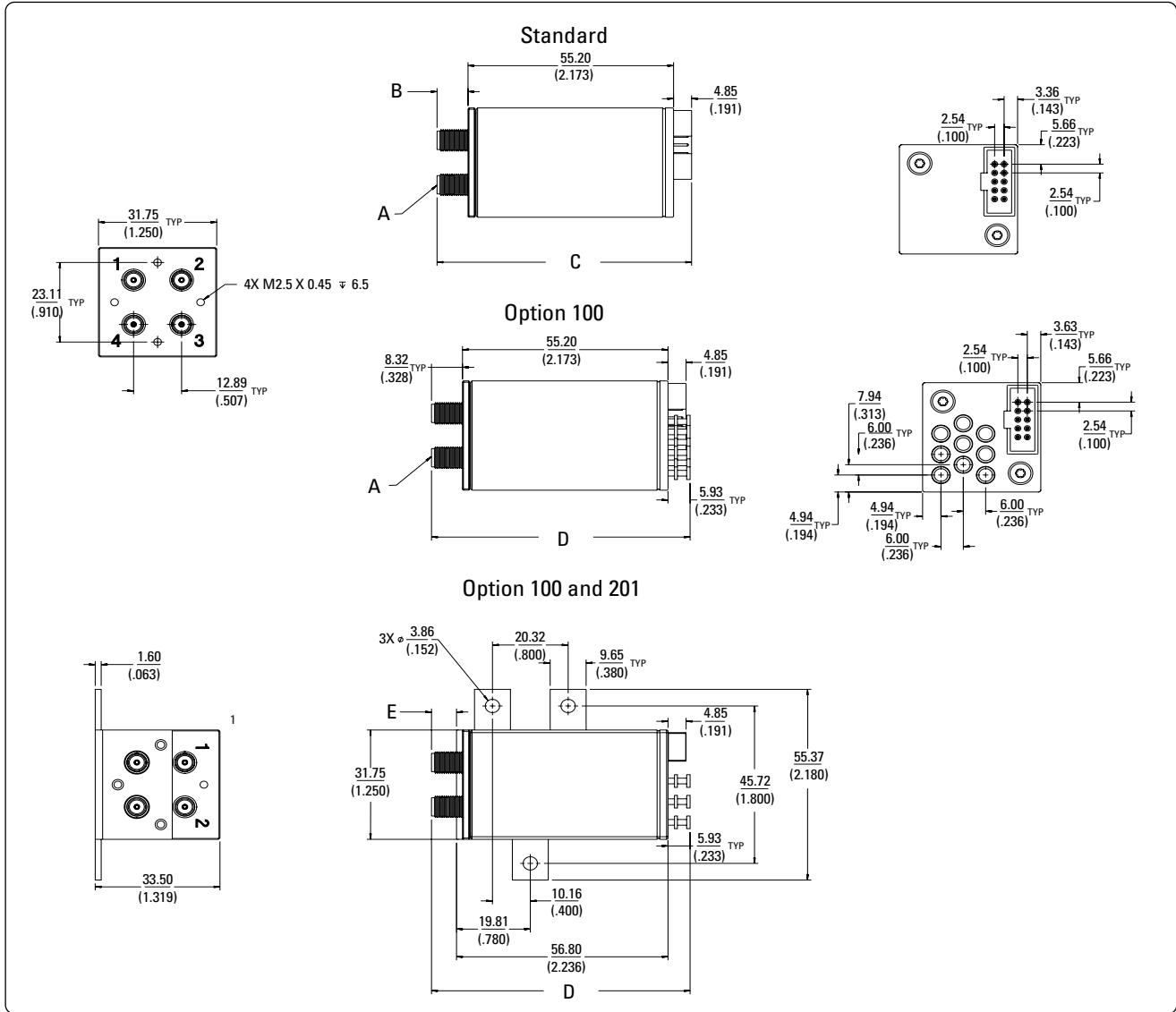

Figure 13. Product outlines

Note: Dimensions are in millimeters and (inches) nominal unless otherwise specified.

Agilent model number	A	B	C	D	E
87222C millimeter (inches)	SMA (f)	8.32 (.328) TYP	REF 68.37 (2.692)	REF 69.46 (2.735)	REF 6.72 (.265)
87222D millimeter (inches)	2.92 mm (f)	8.32 (.328) TYP	REF 68.37 (2.692)	REF 69.46 (2.735)	REF 6.72 (.265)
87222E millimeter (inches)	2.4 mm (f)	9.00 (.354) TYP	REF 69.05 (2.719)	REF 70.14 (2.761)	REF 7.40 (.291)

1. One of four bracket configurations shown.

Ordering guide

Agilent Coaxial transfer switch

- **87222C** dc to 26.5 GHz
- **87222D** dc to 40 GHz
- **87222E** dc to 50 GHz
 - **Option 100** Solder terminals in addition to ribbon cable
 - **Option 201** Mounting bracket-assembly required
 - **Option UK6**¹ Commercial calibration test data with certificate

Accessories available

- **87222-00003** Mounting bracket

Agilent Drivers

- **11713A attenuator switch driver**
Drives up to 31 switches.
- **Accessory cables**
 - **5061-0969** Viking connector to bare tinned wires (60 inches long). Use to connect 11713A to 87222C/D/E with Option 100. Will operate four 87222C/D/E switches.
 - **85124-60002** Viking connector to (4) 10-pin DIP connectors (50 inches long). Will operate four 87222C/D/E switches using the 11713A driver.
- **70611A attenuator/switch driver**²
Drives up to 31 sections of switches or attenuators with Option 001 installed. When expanded with up to 8 external (standard) or 84940A driver cards, the 87130A will drive up to 248 switch or attenuator sections. See below for accessories.
- **87130A attenuator/switch driver**²
Drives up to 31 sections of switches or attenuators. When expanded with up to 7 external 84940A driver cards, the 87130A will drive up to 248 switch or attenuator sections.

Agilent 87130A and 70611A accessories

- **84940A switch driver card**
Will drive up to 31 switch or attenuator sections. For use with 87130A and 70611A.
- **84941A switch interface kit**
Includes a signal distribution card and 70611-60008 accessory cable. For use with the 87222C/D/E with Option 100.
- **11764-60009 accessory cable**²
10-pin DIP to 4-pin Berg Connector (30 inches long).
- **11764-60010 accessory cable for sensing capability**²
10-pin DIP to 4-pin Berg Connector (30 inches long).

Configuration guide

See publication 5963-2038E.

1. Option UK6 not available with 87222D.
2. The 11764-60009 in combination with 87130A or 70611A does not provide position sensing capability. Use the 11764-60010 if position sensing is required.



Agilent Email Updates

www.agilent.com/find/emailupdates

Get the latest information on the products and applications you select.



Agilent Open

Agilent Open simplifies the process of connecting and programming test systems to help engineers design, validate and manufacture electronic products. Agilent offers open connectivity for a broad range of system-ready instruments, open industry software, PC-standard I/O and global support, which are combined to more easily integrate test system development.



Agilent Direct

www.agilent.com/find/agilentdirect

Quickly choose and use your test equipment solutions with confidence.

www.agilent.com

Agilent Technologies' Test and Measurement Support, Services, and Assistance

Agilent Technologies aims to maximize the value you receive, while minimizing your risk and problems. We strive to ensure that you get the test and measurement capabilities you paid for and obtain the support you need. Our extensive support resources and services can help you choose the right Agilent products for your applications and apply them successfully. Every instrument and system we sell has a global warranty. Two concepts underlie Agilent's overall support policy: "Our Promise" and "Your Advantage."

Our Promise

Our Promise means your Agilent test and measurement equipment will meet its advertised performance and functionality. When you are choosing new equipment, we will help you with product information, including realistic performance specifications and practical recommendations from experienced test engineers. When you receive your new Agilent equipment, we can help verify that it works properly and help with initial product operation.

Your Advantage

Your Advantage means that Agilent offers a wide range of additional expert test and measurement services, which you can purchase according to your unique technical and business needs. Solve problems efficiently and gain a competitive edge by contracting with us for calibration, extra-cost upgrades, out-of-warranty repairs, and onsite education and training, as well as design, system integration, project management, and other professional engineering services. Experienced Agilent engineers and technicians worldwide can help you maximize your productivity, optimize the return on investment of your Agilent instruments and systems, and obtain dependable measurement accuracy for the life of those products.

For more information on Agilent Technologies' products, applications or services, please contact your local Agilent office.

Phone or Fax

United States:

(tel) 800 829 4444
(fax) 800 829 4433

Canada:

(tel) 877 894 4414
(fax) 800 746 4866

China:

(tel) 800 810 0189
(fax) 800 820 2816

Europe:

(tel) 31 20 547 2111

Japan:

(tel) (81) 426 56 7832
(fax) (81) 426 56 7840

Korea:

(tel) (080) 769 0800
(fax) (080)769 0900

Latin America:

(tel) (305) 269 7500

Taiwan:

(tel) 0800 047 866
(fax) 0800 286 331

Other Asia Pacific

Countries:

(tel) (65) 6375 8100
(fax) (65) 6755 0042

Email: tm_ap@agilent.com

Contacts revised: 05/27/05

**The complete list is available at:
www.agilent.com/find/contactus**

Product specifications and descriptions in this document subject to change without notice.

© Agilent Technologies, Inc. 2001, 2005

Printed in USA, September 13, 2005

5968-2216E



Agilent Technologies